



# Colenta<sup>®</sup> SilverFit40

## Silver Recovery System

**SILVER RECOVERY REMAINS A VERY IMPORTANT MEANS TO REDUCE FILM PROCESSING COSTS.....The Colenta SilverFit 40 uses up-to-date technology incorporating microprocessor based algorithms for high efficiency silver recovery.**

**Specifications:**

- Overflow based, silver recovery system with a 40 litre tank volume
- 4 graphite anodes provide uniform current distribution
- High power electrolysis of max 13grams of silver per hour (depending on silver load)

**Standard Features :**

- compact / robust design - ease of operation
- double impeller circulation system
- liftable top cover for easy maintenance
- low voltage operation (no 230VAC within the unit)
- micro processor based providing continuous monitoring
- power consumption at 24VDC - 72W
- CE declaration

**microprocessor controlled display**

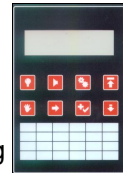

**Standard accessories:**

- silver measure test strips
- set of anode (4x) and cathode (1x)
- small user spare part kit
- 2 x PVC handling tray

**Working description:**

Fixer overflow is supplied from the processor, based on the set replenishment rate. Via the interface (when online), the CPU of the silver recovery unit is using this information to precisely calculate the required current and working time.

According a set algorithm, the more fixer from the processor then a higher electrolyse current is applied, the less fixer overflow the lower the current which is applied, this protects the system against sulphating.

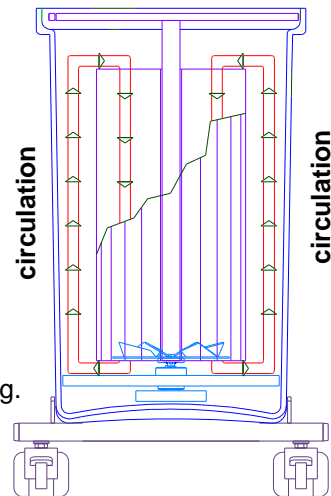

A specific circulation flow is generated between anode & cathode to ensure a uniform silver deposit.

By using with a Colenta processor, the Colenta SilverFit 40 allows the possibility of an online interface connection whereby the values such as replenishment rates, number of replenish cycles, process monitoring and error code management are under continuous supervision.

This communication is unique in the market and only available from Colenta (as the processor manufacturer) and ensures a stable workflow and a high efficient siver recovery process the minimum of user input.

a Colenta NDT Processor connected to a SilverFit 40



a Colenta PCB Processor connected to a SilverFit 40



The Colenta SilverFit 40, can also be used as a „stand alone“ unit and connected to any processor which provides the facility to collect the FIX overflow separately.



# Colenta<sup>®</sup> SilverFit40

## Silver Recovery System

All Colenta silver recovery units are fully factory tested and checked. All components and materials being used are to the highest standards and subject to continued quality control. Resulting in long life and low maintenance cost.



robust & chemical resistant PA tank

Stainless steel cathode



PVC tray

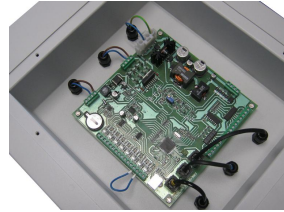

well protected placed and easy maintainable CPU & electronics

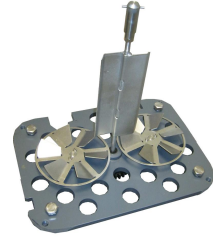

double propeller circulation system (stainless steel)

### standard safety features:

- external low voltage power supply
- main cover switch
- low & high level sensors within the recovery tank
- extra sealing kit between the electrolyse tank & all sensitive working parts
- short circuit safety control between anode & cathode
- self stabilised electronics

use this link for further information as well as to see demo video:

<http://www.colenta.at/silverfit40/silverfit.php>

### Dimensions:

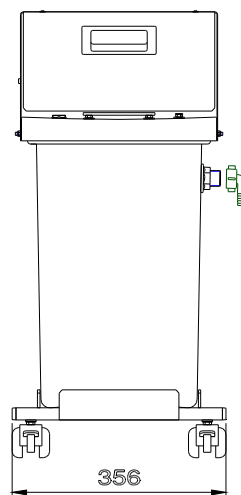
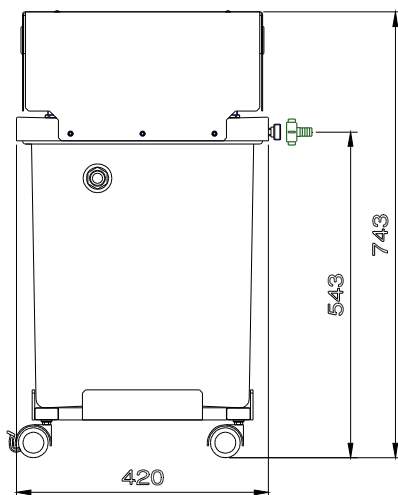

# Colenta<sup>®</sup>

## SilverFit40

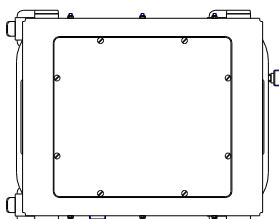

**COLENTA LABORTECHNIK**  
G.m.b.H. & Co. KG  
Neunkirchner Strasse 117  
A-2700 Wiener Neustadt  
Tel.: +43-2622-28311-0  
Fax: +43-2622-28311-7  
E-mail: [office@colenta.at](mailto:office@colenta.at)  
<http://www.colenta.at>

**ACI-COLENTA**  
INTERNATIONAL Div.  
Capix House, Unit 29  
Levellers Lane, Eynesbury  
St Neots. Cambs. UK. PE19 2JL  
Tel. +44-1480-211118  
Fax: +44-1480-215236  
E-mail: [aci@patflaherty.com](mailto:aci@patflaherty.com)

Technical specification subject to change without notice.